

SPECIFICATION

for

SWITCHING POWER SUPPLY

M/N : SNP-Z101

Reviewed by Project Manager						
Typed by Document Assistant						
SKYNET ELECTRONIC			LAST REV. NO.			

1.0 INTRODUCTIONS

The SNP-Z101 is a triple output 110W switching power supply which designed to meet Harmonics EN61000-3-2.

2.0 INPUT SPECIFICATIONS

2.1 Input Voltage

The range of input voltage is from 90VAC to 264VAC. The nominal voltage is 115VAC 60Hz and 230VAC 50Hz.

2.2 Input frequency

The range of input frequency is from 47Hz to 63Hz.

2.3 Input current

The maximum input current is 2A at 115VAC or 1A at 230VAC.

2.4 Inrush current

The inrush current will not exceed 30A at 115VAC input or 60A at 230VAC input, cold start, 25 degree C.

3.0 OUTPUT SPECIFICATIONS

3.1 Load range

output	min. load	rated load	max. load	voltage accuracy
+5V	0A	11.5A	15A	4.95V to 5.05V
+12V	0A	3A	5A	11.40V to 12.60V
-12V	0A	0.5A	0.5A	-11.40V to -12.60V

At factory, all outputs in 60% rated load the +5V output is set to between 5.03V + -0.02V. The + -12V output is checked to be within the specified voltage accuracy range. (Test at nominal line input)

3.2 Output power

The max. power is 130W that works with 18CFM air forced cooling.

3.3 Ripple and noise

The peak to peak ripple and noise for each output is less than 1% of output voltage at rated load and nominal line. Measuring is done by 15MHz band width limited oscilloscope and terminated each output with a 22uF + 0.47uF capacitor.

3.4 Line regulation

The line regulation for each output is less than + -0.5%, measuring at rated load and changing + -10% of nominal input voltage.

3.5 Load regulation

The load regulation for +5V is less than + -1%, for + -12V is less than + -5%, measuring is done by changing the measured output load + -40% from 60% rated load and keep the other output at 60% rated load while the input at nominal line.

4.0 GENERAL FEATURES

4.1 Efficiency

The efficiency is 80% Typ. by measuring at nominal line and rated load.

4.2 Hold up time

The hold up time is longer than 20mS typ at 115VAC input and rated load which is measured from the end of the last charging pulse to when the main output drops down to 95% output voltage.

4.3 Protection

The build-in over voltage protection circuit will shut down the outputs to prevent damaging external circuits, the trip point is around 5.7V to 7.0V for +5V output. The power supply will go into auto-recovery mode against short circuit or over load conditions.

5.0 ENVIRONMENT SPECIFICATIONS

5.1 Operating temperature

0°C to 50°C

100W with convection cool.

130W with 18 CFM air Flow.

The air direction is from the side of PCB.

5.2 Storage temperature

-40°C to 85°C

5.3 Operating humidity

5 ~95% RH, non-condensing .

6.0 INTERNATIONAL STANDARDS

6.1 Safety standards

Designed to meet the following standards :

UL 60950

CSA 22.2 NO.234

EN 60 950

6.2 EMI standards

Designed to meet the following limits :

FCC docket 20780 curve "B"

EN 55022 "B"

EN 61000-3-2

6.3 EMS standards

Designed to meet the following standards :

EN61000-4-2	6KV contact discharge, 8KV air discharge criteria A
EN61000-4-3	10V/m criteria A
EN61000-4-4	2KV criteria A
EN61000-4-5	2KV criteria A
EN61000-4-6	3V criteria A
EN61000-4-11	30% dips 10ms criteria B 60% dips 100ms criteria C 95% dips 5000ms criteria C

7.0 MECHANICAL SPECIFICATION

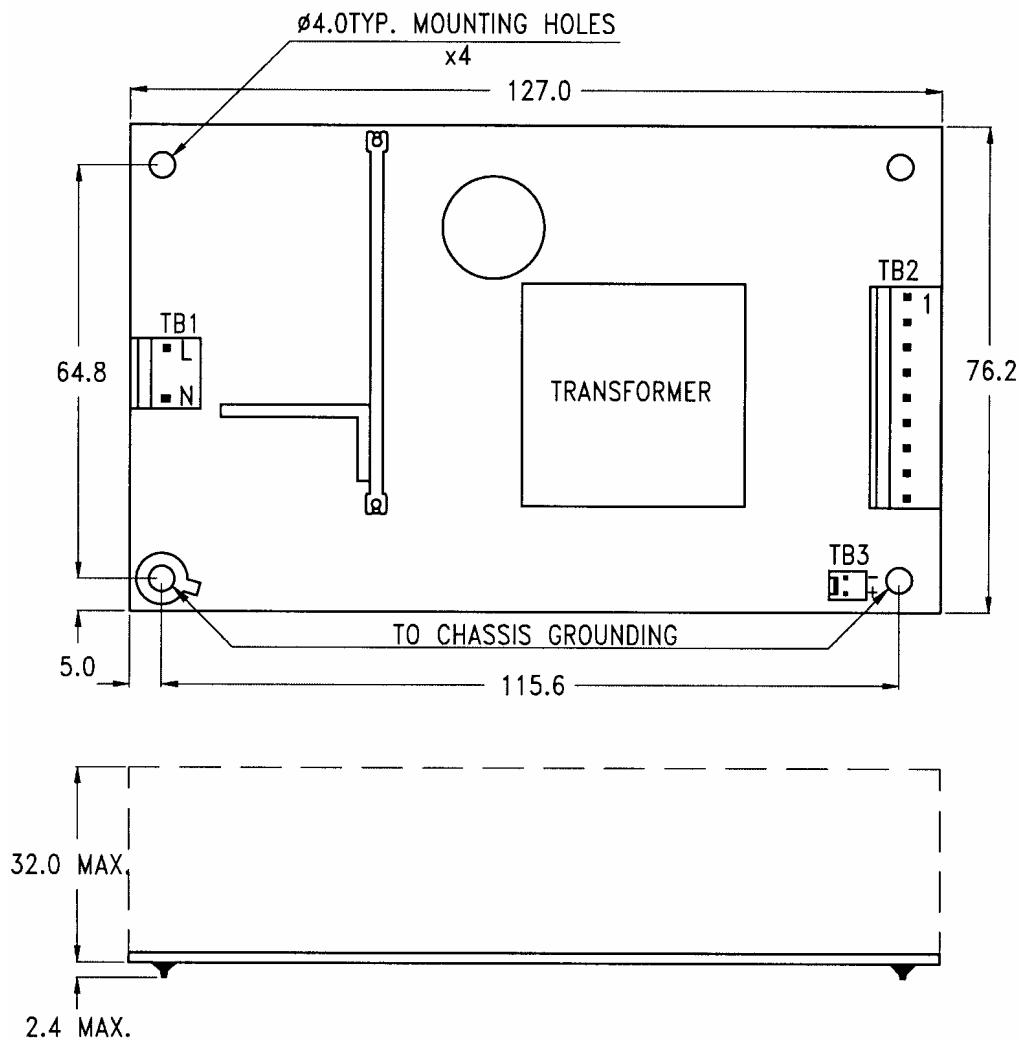

7.1 Dimensions

Dimensions shown in mm as above. Tolerance specified is + -0.4mm.

7.2 Connectors

- TB1--AC input : Molex 5277-02A or equivalent
- TB2--DC output : Molex 5273-09A or equivalent
- TB3 for Fan use : Molex 5045-02A or equivalent

7.3 DC output pin assignment

Pin 1.	+5V	4.	GND	7.	GND
2.	+5V	5.	GND	8.	+12V
3.	+5V	6.	GND	9.	-12V

8.0 PERFORMANCE (input voltage is 115VAC, unless others specified)

8.1 Switching frequency ripple

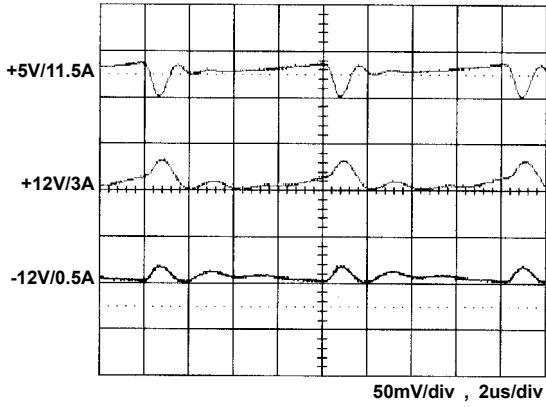

8.2 Line frequency ripple

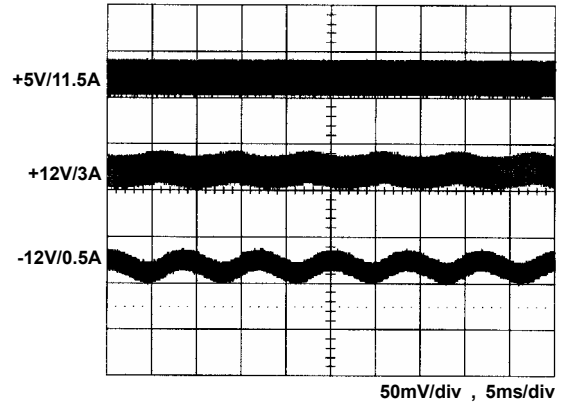

8.3 Output turn on wave form

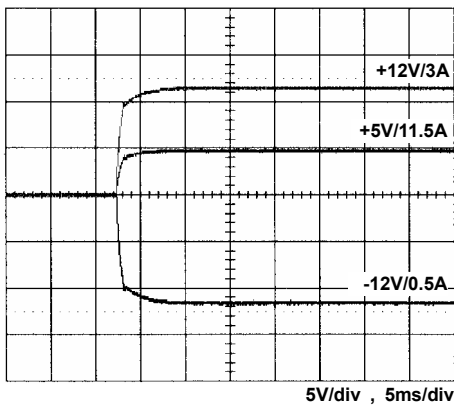

8.4 Output turn off wave form

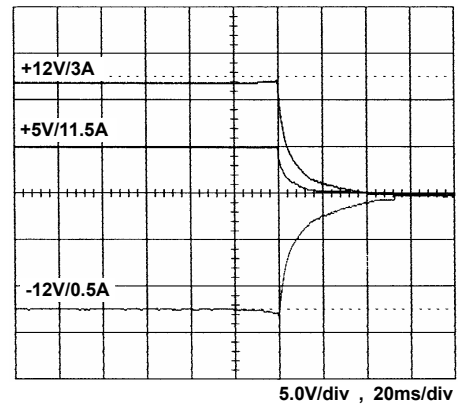

8.5 Hold-up time

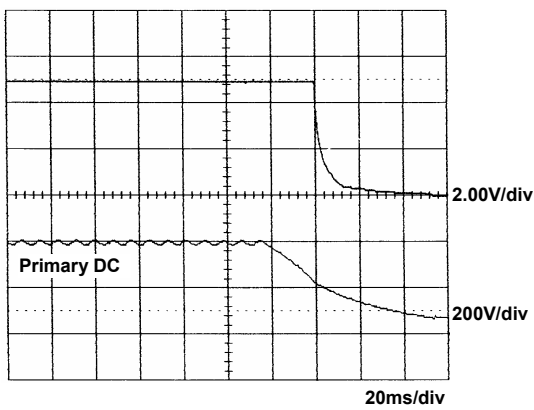

8.6 Over voltage protection

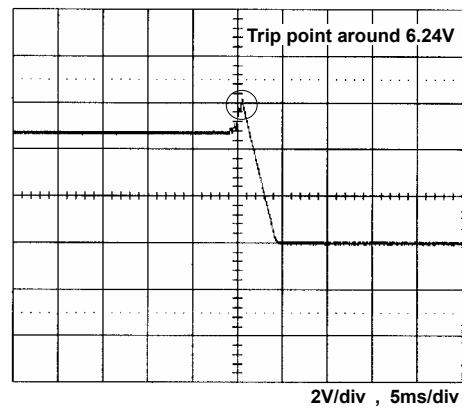

8.7 +5V step response

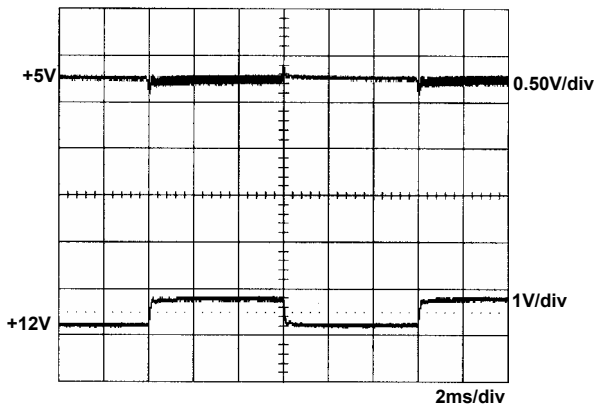

+5V step from 2.3A to 11.5A
other output at 60% load

8.8 +12V step response

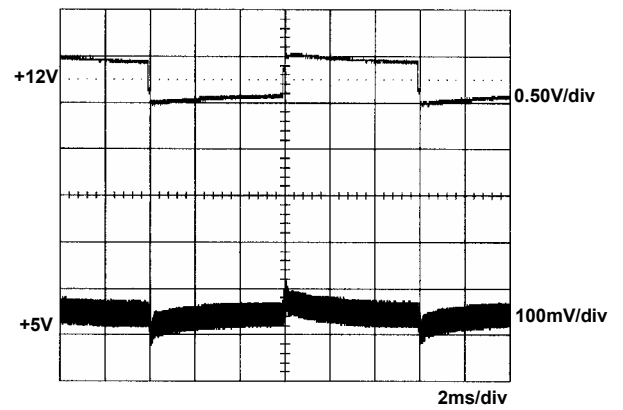

+12V step from 0.6A to 3A
other output at 60% load

8.9 FCC B performance

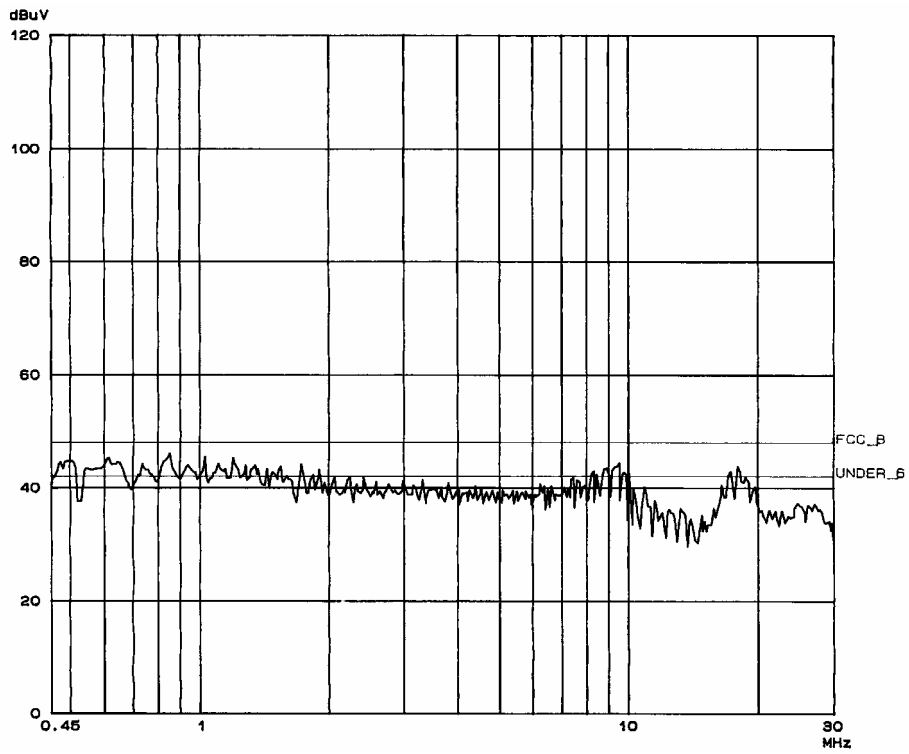

8.10 EN 55022 B

